

Available top finishes:

- MFC
- MFC 3D
- MDF PerfectSense

Telescopic beam.
Epoxy powder painting :
Grey RAL 9006
White RAL 9003

Steel sheet metal Flip top mechanism
with release handles.
Cover in polypropylene (PP).

Leg with steel tube leg in a 80x60
mm rectangular section and folded
sheet foot 70x30 mm.
Epoxy powder painting :
Grey RAL 9006 glossy
White RAL 9003 glossy

Steel box for 4 or 6 module with electrical
and/or multimedia system.
Painted White, Black or Grey.
Available with cable management (optional)

Plastic holder

Height adjustment button with ISP
security system (the table stops and
moves it about 25 mm away from the
obstacles)

n. 2 electrical sockets Schuko Italian.

Swivel castor with kick pedal brake
Ø 75 mm, polyamide support and
thermoplastic rubber.

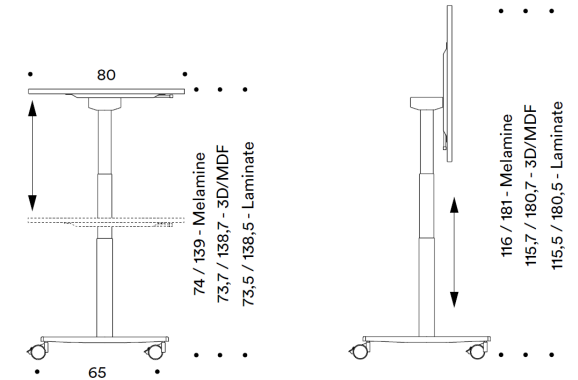

Structure Finishes



Rectangular section steel tube leg 80x60 mm with folded sheet metal foot 70x30 mm.
 Epoxy powder painting.
 Available with 2 finishing:
 Grey RAL 9006 glossy
 White RAL 9003 glossy

Top Finishes

<p>MFC thk.25 mm edge in ABS thk.2 mm</p>	
<p>MFC 3D thk.22 mm edge in ABS thk.1 mm</p>	
<p>MDF PerfectSense thk.22 mm edge in ABS thk.1 mm</p>	
<p>*Writable Laminate thk.20 mm edge in ABS thk.2 mm</p>	

Shapes and tops dimensions

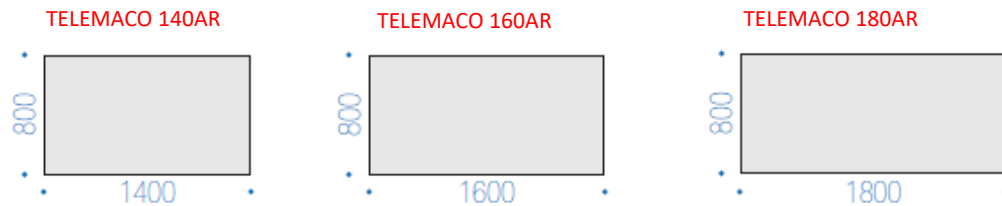

*Available only for Telemaco 160AR/ Electrical Boxes not available with this finishing.

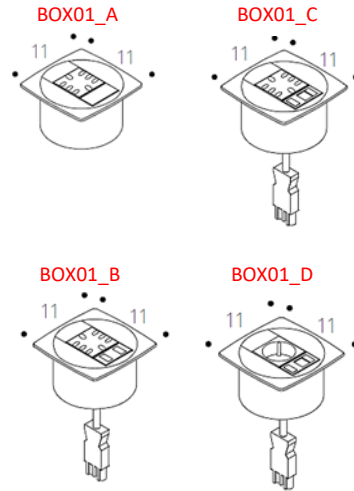

CAV_002
Connection cable between electrical modules 2 mt
(H05VV-F 3G 1.5 mm² / GST18 - GST18).

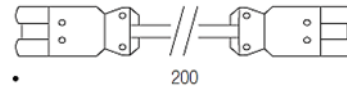

CAV_004
Electric cable 2 mt
(H05VV-F 3G 1.5 mm² / GST18 - Male).

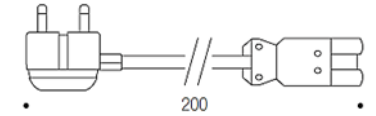

CAV_015
Power distributor with 3 poles.

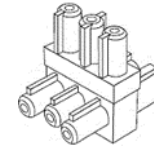

Single module in ABS with electrical and/or multimedia system or cable management.
Available colours Dark grey RAL 7024 and White RAL 9016.

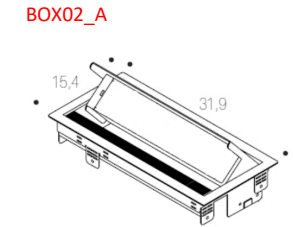
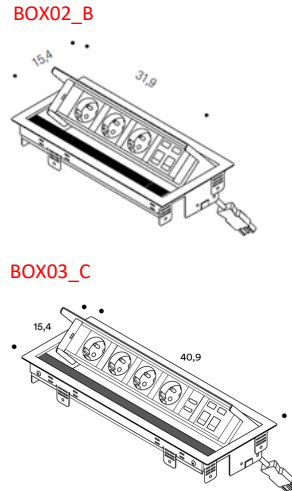

Steel box for 4 or 6 module with electrical and/or multimedia system.
Available colours Black RAL 9017, Grey RAL 9006 and White RAL 9016.

Painted steel cable management resealable module.
Available colours Black RAL 9017, Grey RAL 9006 and White RAL 9016.

National and International Sockets



Multimedia Accessories

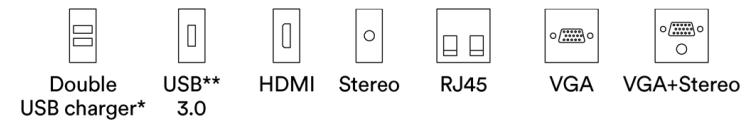

* USB charger only charger
** USB 3.0 only data

Cleaning

For the metal parts, we recommend to use only a damp cloth with alcohol and to dry everything very well after cleaning.

For painted surfaces, please use only a damp cloth with water and neutral liquid detergent. Do not use solvents, trichloroethylene, acetone or ammonia.

Warranty

Telemaco is guaranteed 5 years (full text of warranty on request).



UNI EN 1730:2000

Compliance certificate in accordance with UNI EN 15372:2008, level 2.



Compliance certificate EN ISO/IEC 17050-1.